

AquaShield®

Couplings & Flange Adaptors



AquaShield® - Universal Fittings For Barrier Pipes

DN90 | DN125 | DN180



GB – INSTALLATION INSTRUCTIONS

Safety Installation Notice

You should always adhere to your company health and safety guidelines, method statements, risk assessments and/or safe systems of work that apply to your installations including all applicable PPE requirements in line with your duty of care under relevant OH&S legislation.



VIKING JOHNSON®

PIONEERS IN PIPE SOLUTIONS

AquaShield® Couplings DN90

The barrier pipe clamp bands are supplied pre-assembled and will require loosening before inserting the pipe, although complete dismantling is not advised.

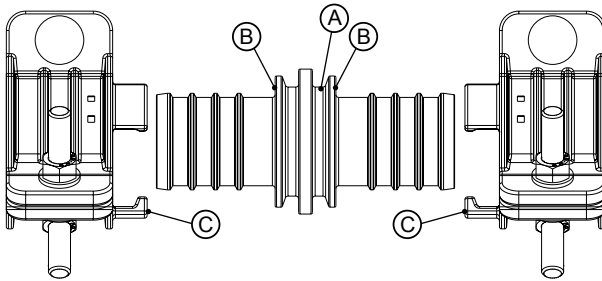

- A) Clamp hook groove
- B) Spigot flange face
- C) Clamp hook

PIPE SYSTEMS CERTIFIED FOR THIS PRODUCT

GPS - Protecta-Line	Radius Systems - Puriton	Egeplast - SLA	PE100
---------------------	--------------------------	----------------	-------

Please read ALL instructions prior to commencing with the assembly.

Note: The following installation instructions are only applicable when the temperature of the pipe is 0°C and above.

1) PRE-ASSEMBLY PREPARATION

Before assembly, ensure that the SDR rating of the pipe is correct for the barrier pipe coupling. If an SDR17 pipe is used on an SDR11 spigot, the fitting will not function. Cut the pipe end as square as possible, and remove any reversion. Ensure both inside and outside of the pipe are free of any dirt, debris, or scoring. The bolts are reversible and can be adjusted to suit the installation.

2 ASSEMBLY OF AQUASHIELD ON PIPE

Loosen the bolts on both sets of clamp bands enough to remove both sets from the coupling. Slide the first clamp band assembly over the first pipe, and the second set onto the other pipe, ensuring that the hooks are facing towards the opening end of the pipe. (Fig. 1). Slide the spigot of the coupling onto the first pipe, ensuring that the end of the pipe is flush with the spigot flange face. Align the clamp band hooks with the groove and then check that the pipe is visible in at least two of the windows, this will ensure the pipe is in the correct position (Fig. 2). Slightly tighten the clamp bands, ensuring that the gaps between each set of clamps is even (Fig 2), so that they are set in the groove and the first pipe is secured. Slide the second pipe onto the other spigot. Check that the pipe is visible in at least two of the windows for both ends of the coupling this will ensure the pipe is in the correct position (Fig. 3).

3) FINAL ASSEMBLY

Working around the fitting, evenly tighten up the bolts sequentially and incrementally, turning each bolt three or four turns at a time with a torque wrench (Fig. 4). There is one bolt per clamp band on 90mm fitting (6 bolts overall). Torque up the bolts using a calibrated torque wrench to a bolt torque of 200-210Nm. Continue working around until the correct bolt torque is achieved on ALL nuts with the torque wrench (Fig. 5).

NOTE: The bolts MUST be torqued up sequentially and incrementally, to ensure the correct function of the product.

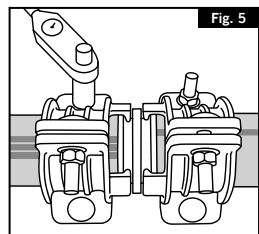
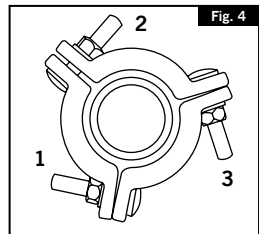
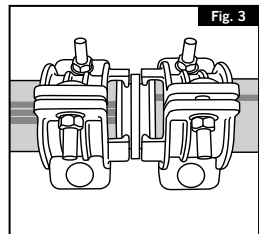
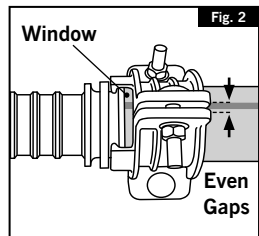
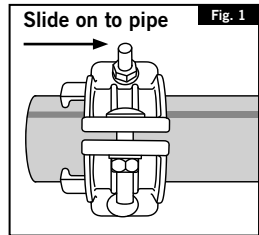

AquaShield® Flange Adaptors DN90

The barrier pipe clamp bands are supplied pre-assembled and will require loosening before inserting the pipe, although complete dismantling is not advised.

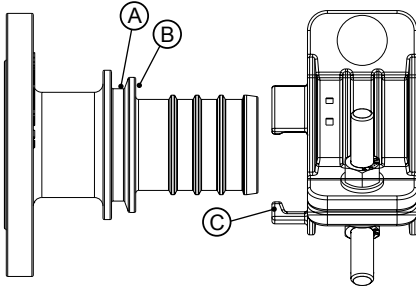

- A) Clamp hook groove
- B) Spigot flange face
- C) Clamp hook

PIPE SYSTEMS CERTIFIED FOR THIS PRODUCT			
GPS - Protecta-Line	Radius Systems - Puriton	Egeplast - SLA	PE100

Please read ALL instructions prior to commencing with the assembly.

Note: The following installation instructions are only applicable when the temperature of the pipe is 0°C and above.

1) PRE-ASSEMBLY PREPARATION

Before assembly, ensure that the SDR rating of the pipe is correct for the barrier pipe flange adaptor. If an SDR17 pipe is used on an SDR11 spigot, the fitting will not function. Cut the pipe end as square as possible, remove any reversion. Ensure both inside and outside of the pipe are free of any dirt, debris, or scoring. The bolts are reversible and can be adjusted to suit the installation.

2) INSTALLATION OF AQUASHIELD ON PLAIN ENDED PIPE

Loosen the bolts on the clamp bands enough to remove the three clamp bands from the flange adaptor. Slide the clamp band assembly over the pipe ensuring that the hooks are facing towards the open end of the pipe, ensuring that the gaps between each set of clamps is even (Fig. 2).

2.1) ASSEMBLY OF AQUASHIELD ON PIPE

Slide the flange adaptor spigot into the pipe, ensuring that the end of the pipe is flush with the spigot flange face. Align the clamp band hooks with the groove and then check that the pipe is visible in at least two of the windows, this will ensure the pipe is in the correct position (Fig. 2). Slightly tighten the clamp bands so that they are set in the groove and the pipe is secured.

2.2) FINAL ASSEMBLY

Working around the fitting, evenly tighten up the bolts sequentially and incrementally, turning each bolt three or four turns at a time with the torque wrench (Fig. 3). There is one bolt per clamp band on 90mm fitting (three bolts overall). Torque up the bolts using a calibrated torque wrench and bolt up to a torque of 200-210Nm. Continue working around until the correct bolt torque is achieved on ALL nuts with the torque wrench (Fig. 4).

NOTE: The bolts MUST be torqued up sequentially and incrementally, to ensure the correct function of the product.

3) INSTALLATION OF PLAIN ENDED PIPE TO A MATING FLANGE WITH AQUASHIELD FLANGE ADAPTOR

Align the AquaShield® flange adaptor and the mating flange such that the bolt holes of the AquaShield® flange and the mating flanges line up. Fit flange gasket (Viking Johnson recommends the use of an Inside Bolt Circle – IBC - gasket) and ensure it is concentric with the flange connecting bolts. Slide the AquaShield® flange adaptor towards the mating flange and bolt them using standard bolting procedures. Install the plain-ended pipe onto the flange adaptor as per the above installation instructions 2.1 and 2.2.

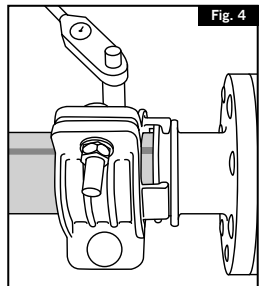
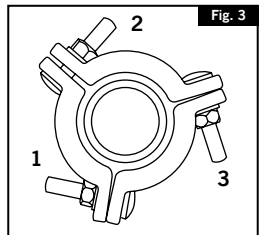
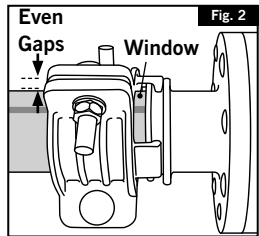
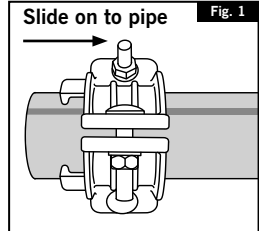

AquaShield® Couplings DN125

The barrier pipe clamp bands are supplied pre-assembled and will require loosening before inserting the pipe, although complete dismantling is not advised.

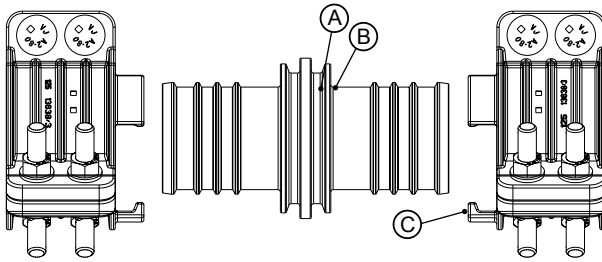

- A) Clamp hook groove
- B) Spigot flange face
- C) Clamp hook

PIPE SYSTEMS CERTIFIED FOR THIS PRODUCT

GPS - Protecta-Line	Radius Systems - Puriton	Egeplast - SLA	PE100
---------------------	--------------------------	----------------	-------

Please read ALL instructions prior to commencing with the assembly.

Note: The following installation instructions are only applicable when the temperature of the pipe is 0°C and above.

1) PRE-ASSEMBLY PREPARATION

Before assembly, ensure that the SDR rating of the pipe is correct for the barrier pipe coupling. If an SDR17 pipe is used on an SDR11 spigot, the fitting will not function. Cut the pipe end as square as possible, and remove any reversion. Ensure both inside and outside of the pipe are free of any dirt, debris, or scoring. The bolts are reversible and can be adjusted to suit the installation.

2 ASSEMBLY OF AQUASHIELD ON PIPE

Loosen the bolts on both sets of clamp bands enough to remove both sets from the coupling. Slide the first clamp band assembly over the first pipe, and the second set onto the other pipe, ensuring that the hooks are facing towards the opening end of the pipe. (Fig. 1). Slide the spigot of the coupling into the first pipe, ensuring that the end of the pipe is flush with the spigot flange face. Align the clamp band hooks with the groove and then check that the pipe is visible in at least two of the windows, this will ensure the pipe is in the correct position (Fig. 2). Slightly tighten the clamp bands, ensuring that the gaps between each set of clamps is even (Fig 2), so that they are set in the groove and the first pipe is secured. Slide the second pipe onto the other spigot. Check that the pipe is visible in at least two of the windows for both ends of the coupling this will ensure the pipe is in the correct position (Fig. 3).

3) FINAL ASSEMBLY

Working around the fitting, evenly tighten up the bolts sequentially and incrementally, turning each bolt three or four turns at a time with a torque wrench (Fig. 4). There are two bolts per clamp band on 125mm fitting (12 bolts overall). Torque up the bolts using a calibrated torque wrench to a bolt torque of 200-210Nm. Continue working around until the correct bolt torque is achieved on ALL nuts with the torque wrench (Fig. 5).

NOTE: The bolts MUST be torqued up sequentially and incrementally, to ensure the correct function of the product.

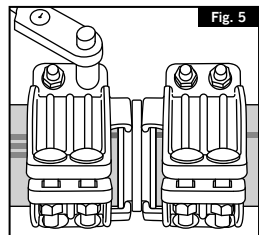
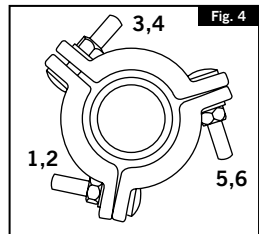
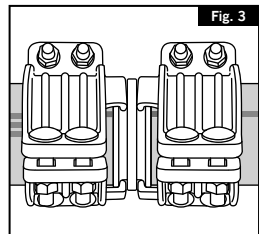
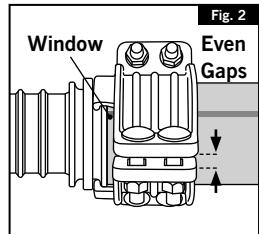
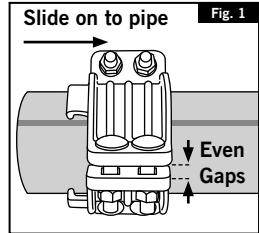

AquaShield® Flange Adaptors DN125

The barrier pipe clamp bands are supplied pre-assembled and will require loosening before inserting the pipe, although complete dismantling is not advised.

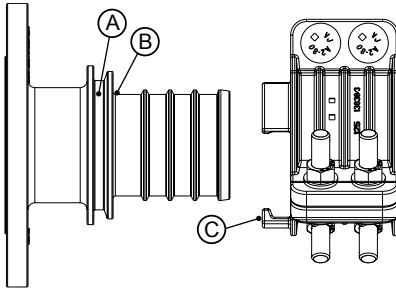

- A) Clamp hook groove
- B) Spigot flange face
- C) Clamp hook

PIPE SYSTEMS CERTIFIED FOR THIS PRODUCT			
GPS - Protecta-Line	Radius Systems - Puriton	Egeplast - SLA	PE100

Please read ALL instructions prior to commencing with the assembly.

Note: The following installation instructions are only applicable when the temperature of the pipe is 0°C and above.

1) PRE-ASSEMBLY PREPARATION

Before assembly, ensure that the SDR rating of the pipe is correct for the barrier pipe flange adaptor. If an SDR17 pipe is used on an SDR11 spigot, the fitting will not function. Cut the pipe end as square as possible, remove any reversion. Ensure both inside and outside of the pipe are free of any dirt, debris, or scoring. The bolts are reversible and can be adjusted to suit the installation.

2) INSTALLATION OF AQUASHIELD ON PLAIN ENDED PIPE

Loosen the bolts on the clamp bands enough to remove the three clamp bands from the flange adaptor. Slide the clamp band assembly over the pipe ensuring that the hooks are facing towards the open end of the pipe, ensuring that the gaps between each set of clamps is even (Fig. 2).

2.1) ASSEMBLY OF AQUASHIELD ON PIPE

Slide the flange adaptor spigot into the pipe, ensuring that the end of the pipe is flush with the spigot flange face. Align the clamp band hooks with the groove and then check that the pipe is visible in at least two of the windows, this will ensure the pipe is in the correct position (Fig. 2). Slightly tighten the clamp bands so that they are set in the groove and the pipe is secured.

2.2) FINAL ASSEMBLY

Working around the fitting, evenly tighten up the bolts sequentially and incrementally, turning each bolt three or four turns at a time with the torque wrench (Fig. 3). There are two bolts per clamp band on 125mm fitting (six bolts overall). Torque up the bolts using a calibrated torque wrench and bolt up to a torque of 200-210Nm. Continue working around until the correct bolt torque is achieved on ALL nuts with the torque wrench (Fig. 4).

NOTE: The bolts MUST be torqued up sequentially and incrementally, to ensure the correct function of the product.

3) INSTALLATION OF PLAIN ENDED PIPE TO A MATING FLANGE WITH AQUASHIELD FLANGE ADAPTOR

Align the AquaShield® flange adaptor and the mating flange such that the bolt holes of the AquaShield® flange and the mating flanges line up. Fit flange gasket (Viking Johnson recommends the use of an Inside Bolt Circle – IBC - gasket) and ensure it is concentric with the flange connecting bolts. Slide the AquaShield® flange adaptor towards the mating flange and bolt them using standard bolting procedures. Install the plain-ended pipe onto the flange adaptor as per the above installation instructions 2.1 and 2.2.

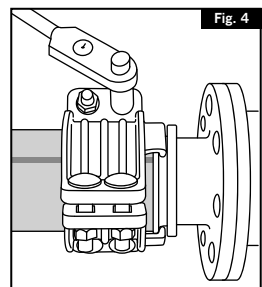
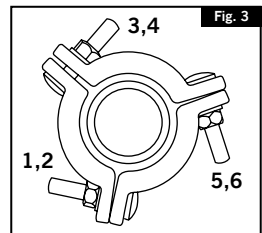
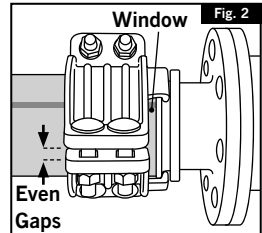
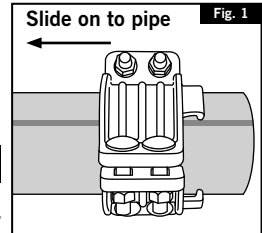

AquaShield® Couplings DN180

The barrier pipe clamp bands are supplied pre-assembled and will require loosening before inserting the pipe, although complete dismantling is not advised.

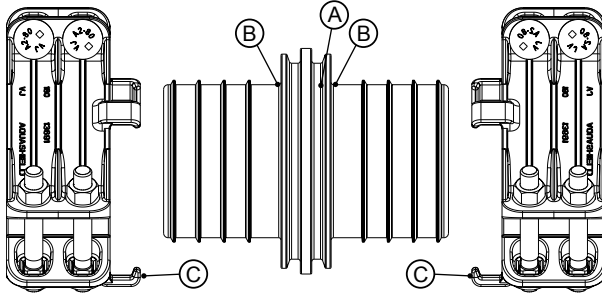

- A) Clamp hook groove
- B) Spigot flange face
- C) Clamp hook

PIPE SYSTEMS CERTIFIED FOR THIS PRODUCT

GPS - Protecta-Line	Radius Systems - Puriton	Egeplast - SLA	PE100
---------------------	--------------------------	----------------	-------

Please read ALL instructions prior to commencing with the assembly.

Note: The following installation instructions are applicable when the temperature of the SDR17 pipe is 0°C and above and the SDR11 pipe is 10 °C and above. For SDR11 at pipe temperatures between 5°C and 10°C, follow the below instructions but re-torque the bolts to the required 200-210 Nm after 30 minutes.

1) PRE-ASSEMBLY PREPARATION

Before assembly, ensure that the SDR rating of the pipe is correct for the barrier pipe coupling. If an SDR17 pipe is used on an SDR11 spigot, the fitting will not function. Cut the pipe end as square as possible, and remove any reversion. Ensure both inside and outside of the pipe are free of any dirt, debris, or scoring. The bolts are reversible and can be adjusted to suit the installation.

2 ASSEMBLY OF AQUASHIELD ON PIPE

Loosen the bolts on both sets of clamp bands enough to remove both sets from the coupling. Slide the first clamp band assembly over the first pipe, and the second set onto the other pipe, ensuring that the hooks are facing towards the opening end of the pipe. (Fig. 2). Slide the spigot of the coupling into the first pipe, ensuring that the end of the pipe is flush with the spigot flange face. Align the clamp band hooks with the groove and then check that the pipe is visible in at least two of the windows, this will ensure the pipe is in the correct position (Fig. 2). Slightly tighten the clamp bands, ensuring that the gaps between each set of clamps is even (Fig 2), so that they are set in the groove and the first pipe is secured. Slide the second pipe onto the other spigot. Check that the pipe is visible in at least two of the windows for both ends of the coupling this will ensure the pipe is in the correct position (Fig. 3).

3) FINAL ASSEMBLY

Working around the fitting, evenly tighten up the bolts sequentially and incrementally, turning each bolt three or four turns at a time with a torque wrench (Fig. 4). There are two bolts per clamp band on 180mm fitting (12 bolts overall). Torque up the bolts using a calibrated torque wrench to a bolt torque of 200-210Nm. Continue working around until the correct bolt torque is achieved on ALL nuts with the torque wrench (Fig. 5).

NOTE: The bolts **MUST** be torqued up sequentially and incrementally, to ensure the correct function of the product.

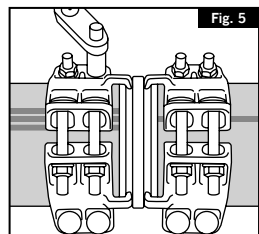
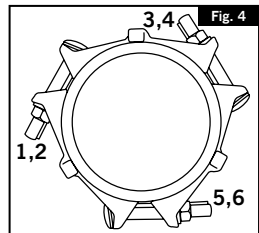
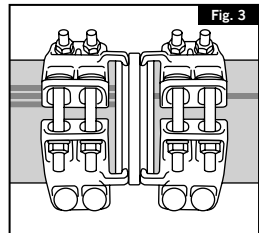
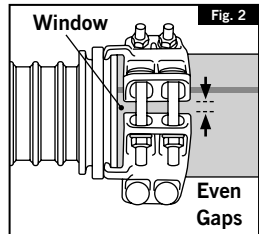
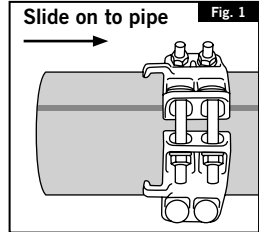

AquaShield® Flange Adaptors DN180

The barrier pipe clamp bands are supplied pre-assembled and will require loosening before inserting the pipe, although complete dismantling is not advised.

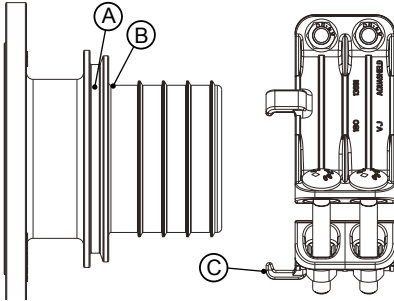

- A) Clamp hook groove
- B) Spigot flange face
- C) Clamp hook

PIPE SYSTEMS CERTIFIED FOR THIS PRODUCT			
GPS - Protecta-Line	Radius Systems - Puriton	Egeplast - SLA	PE100

Please read ALL instructions prior to commencing with the assembly.

Note: The following installation instructions are applicable when the temperature of the SDR17 pipe is 0°C and above and the SDR11 pipe is 10 °C and above. For SDR11 at pipe temperatures between 5°C and 10°C, follow the below instructions but re-torque the bolts to the required 200-210 Nm after 30 minutes.

1) PRE-ASSEMBLY PREPARATION

Before assembly, ensure that the SDR rating of the pipe is correct for the barrier pipe flange adaptor. If an SDR17 pipe is used on an SDR11 spigot, the fitting will not function. Cut the pipe end as square as possible, remove any reversion. Ensure both inside and outside of the pipe are free of any dirt, debris, or scoring. The bolts are reversible and can be adjusted to suit the installation.

2) ASSEMBLY OF AQUASHIELD ON PIPE

Loosen the bolts on the clamp bands enough to remove the three clamp bands from the flange adaptor. Slide the clamp band assembly over the pipe ensuring that the hooks are facing towards the open end of the pipe, ensuring that the gaps between each set of clamps is even (Fig. 2).

2.1) ASSEMBLY OF AQUASHIELD ON PIPE

Slide the flange adaptor spigot into the pipe, ensuring that the end of the pipe is flush with the spigot flange face. Align the clamp band hooks with the groove and then check that the pipe is visible in at least two of the windows, this will ensure the pipe is in the correct position (Fig. 2). Slightly tighten the clamp bands so that they are set in the groove and the pipe is secured.

2.2) FINAL ASSEMBLY

Working around the fitting, evenly tighten up the bolts sequentially and incrementally, turning each bolt three or four turns at a time with the torque wrench (Fig. 3). There are two bolts per clamp band on 180mm fitting (six bolts overall). Torque up the bolts using a calibrated torque wrench and bolt up to a torque of 200-210Nm. Continue working around until the correct bolt torque is achieved on ALL nuts with the torque wrench (Fig. 4). **NOTE:** The bolts MUST be torqued up sequentially and incrementally, to ensure the correct function of the product.

3) INSTALLATION OF PLAIN ENDED PIPE TO A MATING FLANGE WITH AQUASHIELD FLANGE ADAPTOR

Align the AquaShield® flange adaptor and the mating flange such that the bolt holes of the AquaShield® flange and the mating flanges line up. Fit flange gasket (Viking Johnson recommends the use of an Inside Bolt Circle – IBC - gasket) and ensure it is concentric with the flange connecting bolts. Slide the AquaShield® flange adaptor towards the mating flange and bolt them using standard bolting procedures. Install the plain-ended pipe onto the flange adaptor as per the above installation instructions 2.1 and 2.2.

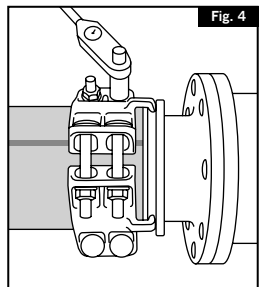
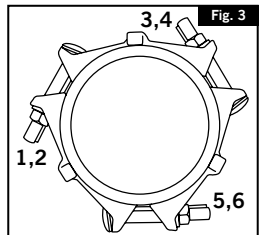
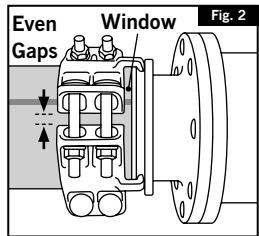
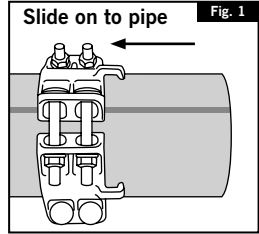

Every effort has been made to ensure that the information contained in this publication is accurate at the time of publishing. Crane Ltd assumes no responsibility or liability for typographical errors or omissions or for any misinterpretation of the information within the publication and reserves the right to change without notice.

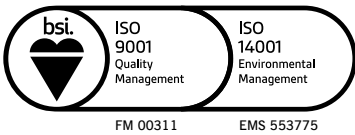

www.vikingjohnson.com/en/category/aquashield



To visit our Video Library go to:
<http://www.youtube.com/user/CraneBSU>

DR11346C_10_08_2023_REV02_R39/050AB



46-48 WILBURY WAY
HITCHIN,
HERTFORDSHIRE
SG4 0UD. UK

TELEPHONE: +44 (0)1462 443322
FAX: +44 (0)1462 443311
EMAIL: info@vikingjohnson.com
www.vikingjohnson.com